



CATÁLOGO DE PARTES

Apache

RTR 160 F4V ABS



WWW.AUTECO.COM.CO/MOTOS



Advierta lo que le dicen las llantas mientras conduce:

- Si su respuesta a la dirección es lenta o si en las curvas y en el frenado la respuesta es pesada, es muy probable que sus llantas estén desinfladas.
- Vibración o tambaleo durante la conducción, puede significar que la presión en las llantas es mayor a la recomendada, o que ha ocurrido un daño en la llanta y la falla es inminente.
- La llanta puede vibrar a ciertas velocidades debido al desbalanceo, en este caso su desgaste será muy acelerado.

**RECUERDE SIEMPRE REVISAR LA PRESIÓN DE AIRE EN SUS LLANTAS
ANTES DE COMENZAR A RODAR**

PREFACIO

Es nuestro placer presentarles a ustedes el Catálogo de Partes.

Este Catálogo ha sido especialmente diseñado para ayudarle en la selección de las partes correctas con el fin de mantener el vehículo en las mejores condiciones.

Los repuestos originales están sujetos a un exigente estándar de control de calidad, por lo tanto es necesario que usted sólo use repuestos originales.


En nuestro constante esfuerzo para mejorar la eficiencia y desempeño de su vehículo, las especificaciones, diagramas y número de partes pueden cambiar sin previo aviso. Consecuentemente las descripciones de los repuestos en este Catálogo pueden no ser las finales y definitivas.

Las alteraciones y modificaciones que ocurren en la impresión de este Catálogo, serán informadas a nuestra red, a través de circulares de Servicio o en nuestra página web: www.auteco.com.co accediendo al link repuestos. Es requisito que usted actualice su Catálogo y haga las correcciones necesarias, una vez reciba dichas circulares. Lo anterior le asegurará un rápido y adecuado despacho de sus partes, pues las órdenes están siendo diligenciadas con las referencias más actualizadas.

En caso de necesitar asistencia técnica, comunicarse con el Distribuidor Autorizado o llamar al Departamento de Servicios Auteco.

SERVICIO AL CLIENTE

LÍNEA ÚNICA DE SERVICIO AL CLIENTE CANAL

(4) 444 81 90 

ATENCIÓN EN:	NOMBRE	E-MAIL
SERVICIO PAGO ANTICIPADO JEFE POSVENTA REPUESTOS MOTO FUERA DE RUTA	JEISSON ALEXANDER ALVAREZ M. ANDREA ARROYAVE ARCILA	repuestosauteco1@auteco.com.co aarroyave@autecomobility.com motofueraderuta@auteco.com.co

AUTOTECNICA COLOMBIANA S.A.S (AUTECO S.A.S) SEDE PRINCIPAL CRA. 43 # 44-60 ITAGÜI ANT. - PBX: (4)306 81 81

Atención a clientes finales: LÍNEA GRATUITA NACIONAL - 01 800052 00 90

ARRANCA EL
2022
SOBRE
RUEDAS

 auteco

LLANTAS NUEVAS PARA TU MOTO



 TVS TYRES

MOTOCARRO

SCOOTER

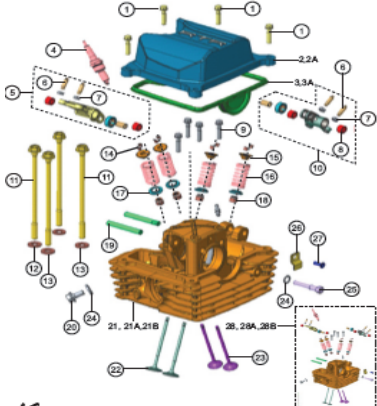
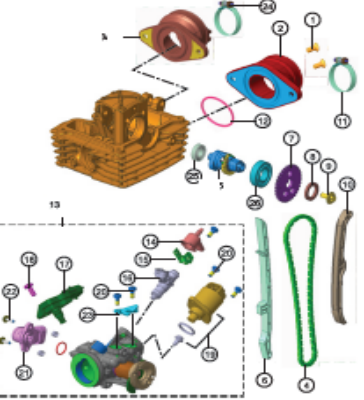
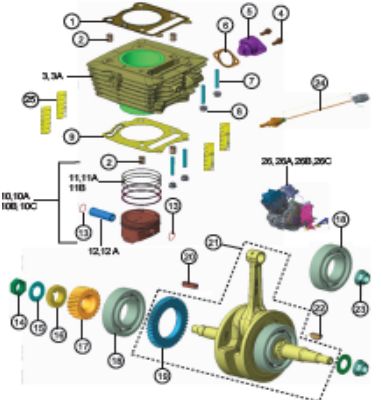
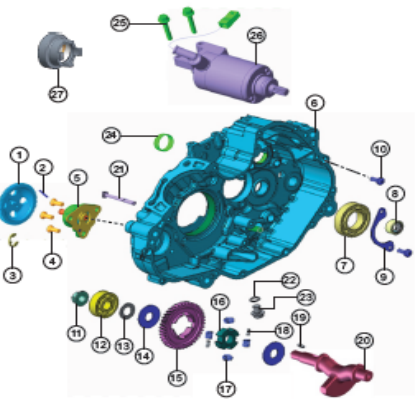
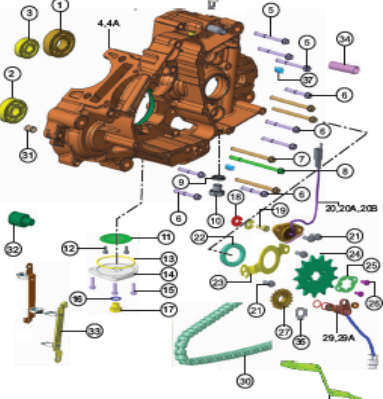
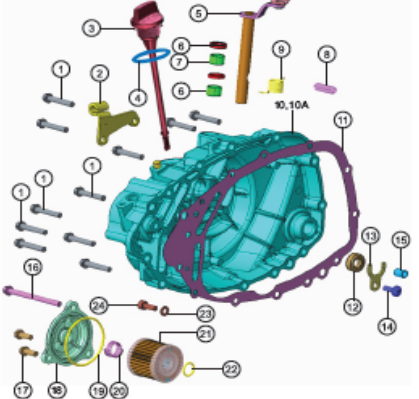
SEMIPISTERA

PISTERA

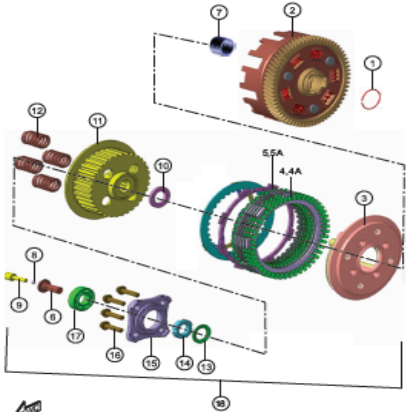
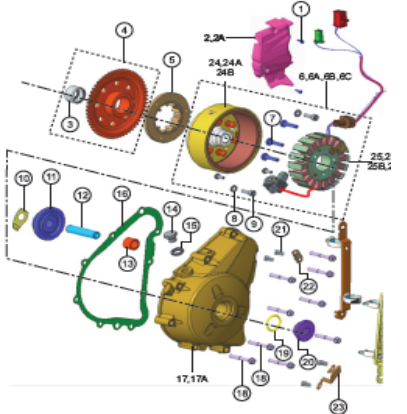
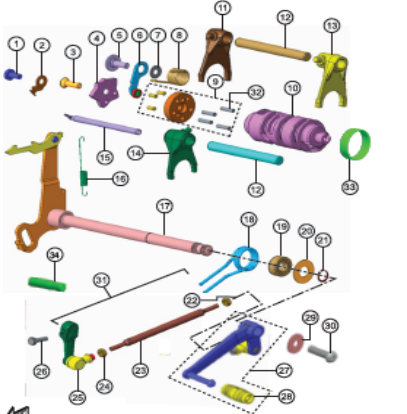
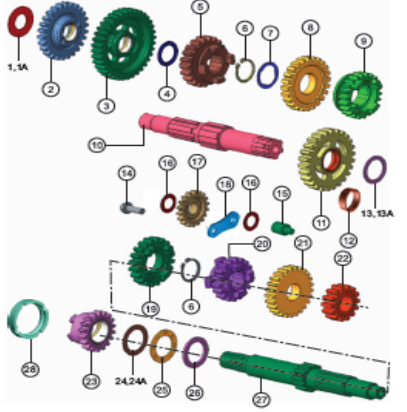
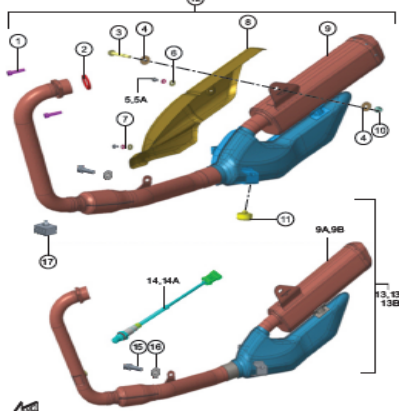
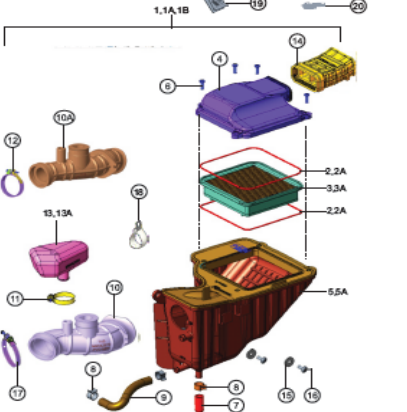
ÍNDICE

FIGURA Nº	DESCRIPCIÓN	PÁG. Nº	FIGURA Nº	DESCRIPCIÓN	PÁG. Nº
1	CULATA	1-2	26	VELOCÍMETRO	36
2	EJE DE LEVAS / CUERPO DE INYECCIÓN	3	27	FAROLA	37
3	CILINDRO / PISTÓN / CIGUEÑAL	4-5	28	DIRECCIONALES DELANTERAS	38
4	CARCASA DERECHA / BALANCEADOR	6-7	29	CUBIERTAS / TAPAS LATERALES	39
5	CARCASA IZQUIERDA	8-9	30	GUARDABARRO DELANTERO	40
6	CUBIERTA CLUTCH	10	31	GUARDABARRO TRASERO	41-42
7	CLUTCH	11	32	SUSPENSIÓN DELANTERA MARCA SHOWA	43-44
8	CUBIERTA VOLANTE / VOLANTE	12	33	SUSPENSIÓN DELANTERA MARCA GABRIEL	45-46
9	SELECTOR DE CAMBIOS	13-14	34	STOP	47
10	TRANSMISIÓN	15-16	35	EQUIPO ELÉCTRICO	48-49
11	SILENCIADOR	17	36	BRAZO OSCILANTE / AMORTIGUADOR	50
12	CAJA FILTRO DE AIRE	18	37	BOMBA FRENO DELANTERA	51-52
13	RADIADOR	19	38	BOMBA DE FRENO TRASERA	53-54
14	TANQUE GASOLINA	20	39	CALIPER DELANTERO	55
15	TANQUE GASOLINA Y COMPONENTES	21	40	SISTEMA FRENOS ABS	56
16	CANISTER	22	41	HERRAMIENTA	57
17	CUBIERTAS TANQUE GASOLINA	23	42	PARTES SIN PINTAR	58
18	CHASIS	24-25	43	CALCOMANÍAS	59-60-61
19	REPOSAPIÉS DELANTERO DERECHO E IZQUIERDO	26-27	44	LISTA DE KITS	62 AL 66
20	REPOSAPIÉS TRASERO DERECHO E IZQUIERDO	28			
21	GATO CENTRAL / GATO LATERAL	29			
22	SILLÍN	30			
23	MANUBRIO	31-32			
24	RUEDA DELANTERA	33			
25	RUEDA TRASERA	34-35			

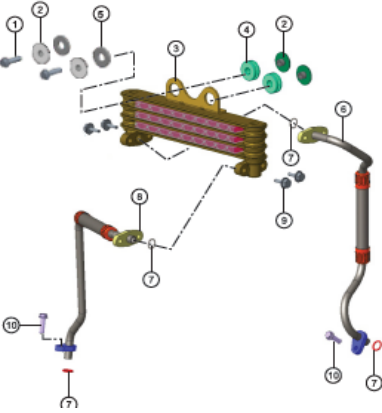
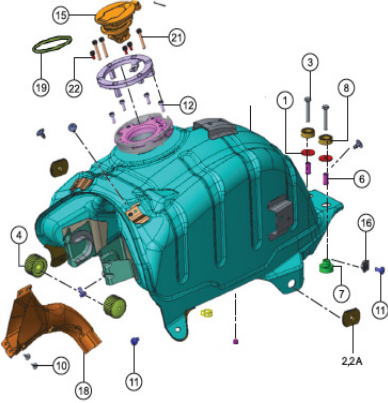
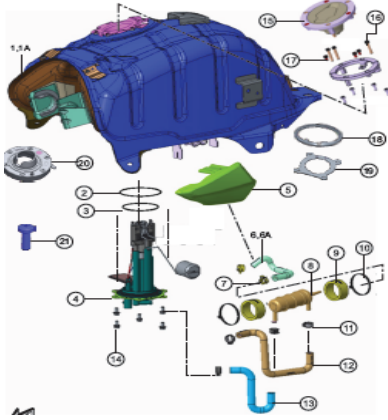
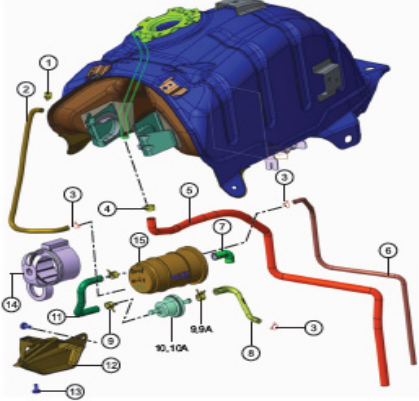
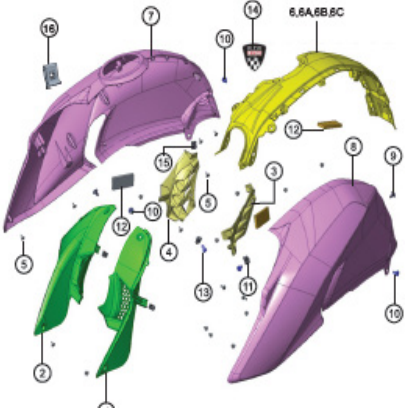
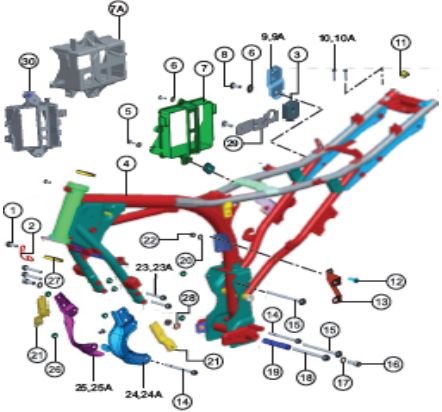
ÍNDICE DE GRÁFICOS

	<p style="text-align: center;">3.No. 02</p> 				
<p>FIGURA N° 1: CULATA</p>	<p>PÁG. N°. 1/2</p>	<p>FIGURA N° 2: EJE DE LEVAS / CUERPO INY.</p>	<p>PÁG. N°. 3</p>	<p>FIGURA N° 2: CILINDRO / PISTÓN</p>	<p>PÁG. N°. 4/5</p>
					
<p>FIGURA N° 4: CARCASA DERECHA / BALAN.</p>	<p>PÁG. N°. 6/7</p>	<p>FIGURA N° 5: CARCASA IZQUIERDA</p>	<p>PÁG. N°. 8/9</p>	<p>FIGURA N° 6: CUBIERTA CLUTCH</p>	<p>PÁG. N°. 10</p>

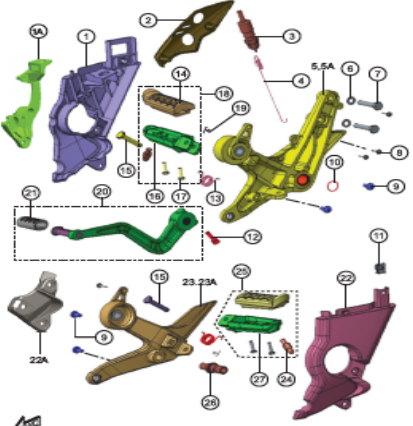
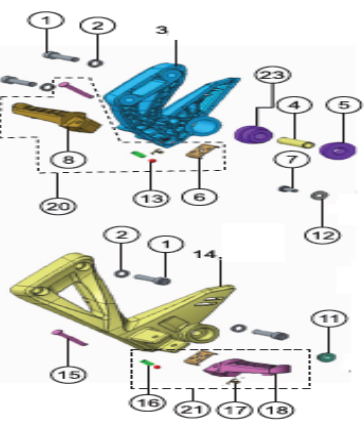
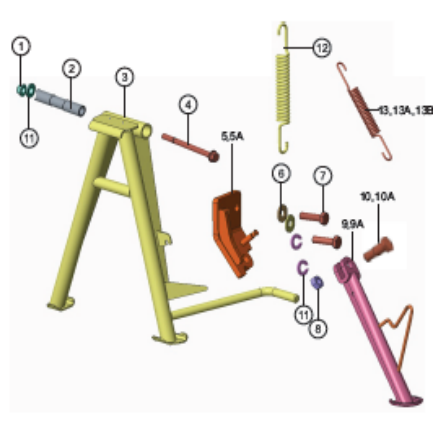
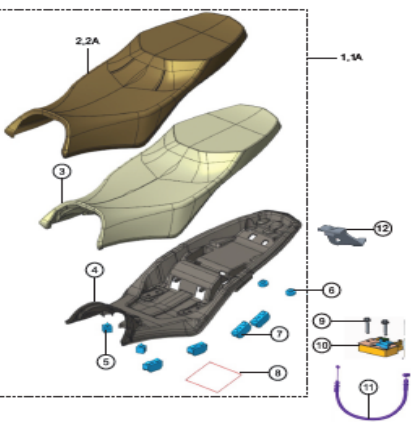
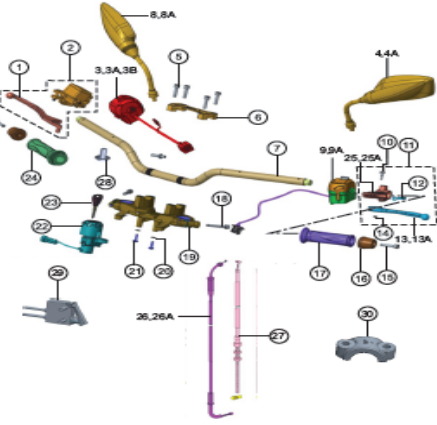
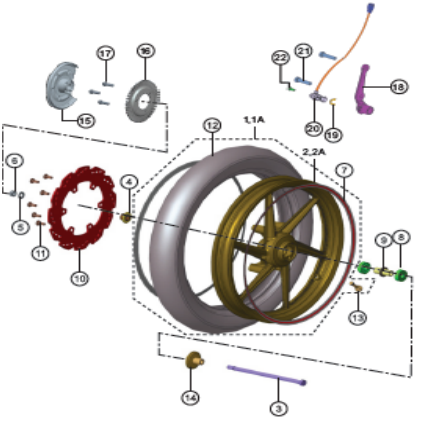
ÍNDICE DE GRÁFICOS

					
<p>FIGURA N° 7: CLUTCH</p>	<p>PÁG. N° 11</p>	<p>FIGURA N° 8: CUBIERTA VOLANTE / VOL.</p>	<p>PÁG. N° 12</p>	<p>FIGURA N° 9: SELECTOR DE CAMBIOS</p>	<p>PÁG. N° 13/14</p>
					
<p>FIGURA N° 10: TRANSMISIÓN</p>	<p>PÁG. N° 15/16</p>	<p>FIGURA N° 11: SELECTOR DE CAMBIOS</p>	<p>PÁG. N° 17</p>	<p>FIGURA N° 12: CAJA FILTRO AIRE</p>	<p>PÁG. N° 18</p>

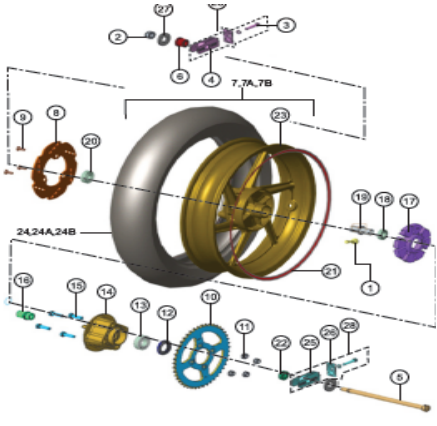
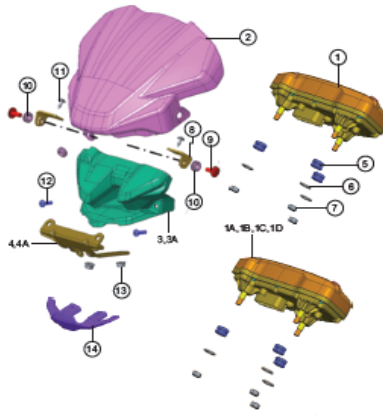
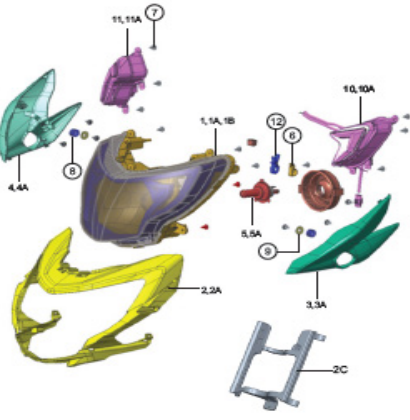
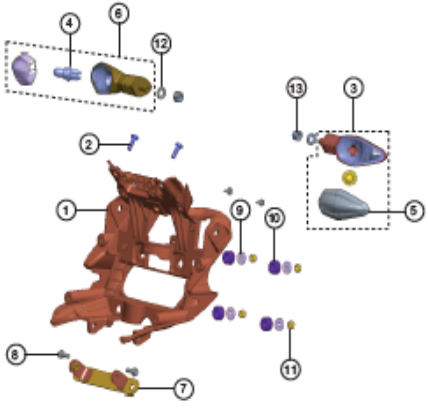
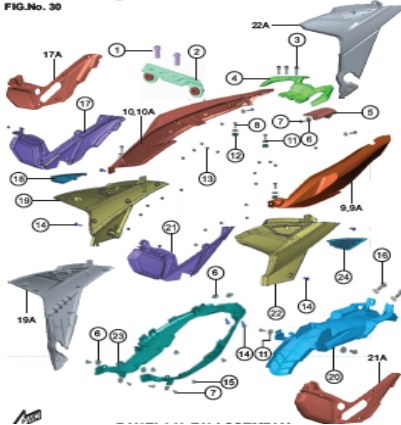
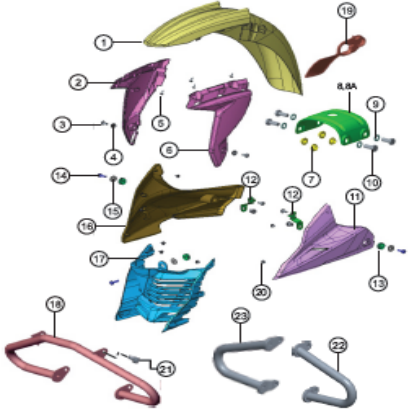
ÍNDICE DE GRÁFICOS

		
<p>FIGURA N° 13: RADIADOR</p>	<p>FIGURA N° 14: TANQUE GASOLINA</p>	<p>FIGURA N° 15: TANQUE GAS. Y COMPONENTES</p>
		
<p>FIGURA N° 16: CANISTER</p>	<p>FIGURA N° 17: CUBIERTAS TANQUE GAS.</p>	<p>FIGURA N° 18: CHASIS</p>
<p>PÁG. N° 19</p>	<p>PÁG. N° 20</p>	<p>PÁG. N° 21</p>
<p>PÁG. N° 22</p>	<p>PÁG. N° 23</p>	<p>PÁG. N° 24/25</p>

ÍNDICE DE GRÁFICOS

	<p>FIGURA N° 19: REPOSAPIÉS DELANTEROS</p> <p>PÁG. N° 26/27</p>		<p>FIGURA N° 20: REPOSAPIÉS TRASEROS</p> <p>PÁG. N° 28</p>		<p>FIGURA N° 21: GATO CENTRAL Y LATERAL</p> <p>PÁG. N° 29</p>
	<p>FIGURA N° 22: SILLÍN</p> <p>PÁG. N° 30</p>		<p>FIGURA N° 23: MANUBRIO</p> <p>PÁG. N° 31/32</p>		<p>FIGURA N° 24: RUEDA DELANTERA</p> <p>PÁG. N° 33</p>

ÍNDICE DE GRÁFICOS

	<p>FIGURA N° 25: RUEDA TRASERA</p> <p>PÁG. N°. 34/35</p>		<p>FIGURA N° 26 VELOCIMETRO</p> <p>PÁG. N°. 36</p>		<p>FIGURA N° 27: FAROLA</p> <p>PÁG. N°. 37</p>
	<p>FIGURA N° 28: DIRECCIONALES DEL.</p> <p>PÁG. N°. 38</p>		<p>FIGURA N° 29: CUBIERTAS Y TAPAS LAT.</p> <p>PÁG. N°. 39</p>		<p>FIGURA N° 30: GUARDABARRO DEL.</p> <p>PÁG. N°. 40</p>

ÍNDICE DE GRÁFICOS

	<p>PÁG. N° 41/42</p>		<p>PÁG. N° 43/44/45/46</p>		<p>PÁG. N° 47</p>
	<p>PÁG. N° 48/49</p>		<p>PÁG. N° 50</p>		<p>PÁG. N° 51/52</p>

ÍNDICE DE GRÁFICOS

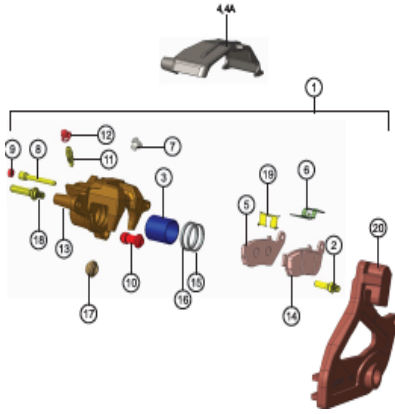
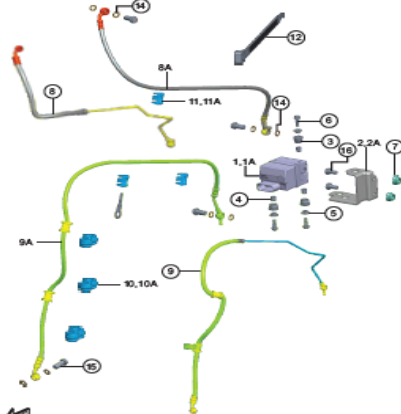
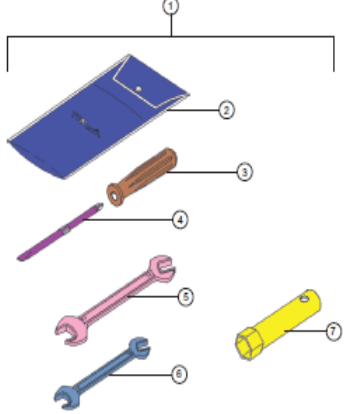
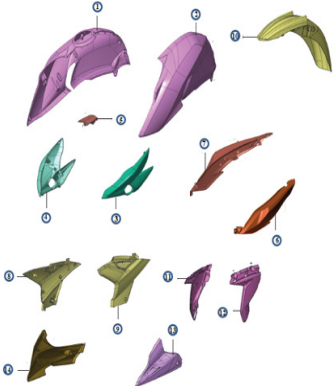

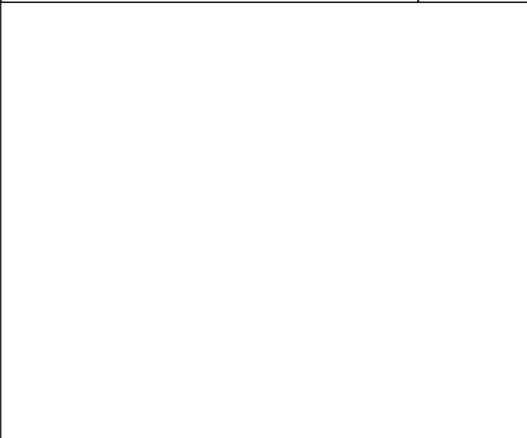
			
FIGURA N° 38: CALIPER TRASERO	FIGURA N° 39: SISTEMA FRENOS ABS	FIGURA N° 40: HERRAMIENTA	
	<p style="text-align: center;">Apache 160 4V FI Top Frost Calcomanía Gris MY24</p> 		
FIGURA N° 41: PARTES SIN PINTAR	FIGURA N° 42/43/44: CALCOMANÍAS	PÁG. N° 58	PÁG. N° 59/60/61

FIGURA N° 2: EJE DE LEVAS Y CUERPO DE INYECCIÓN

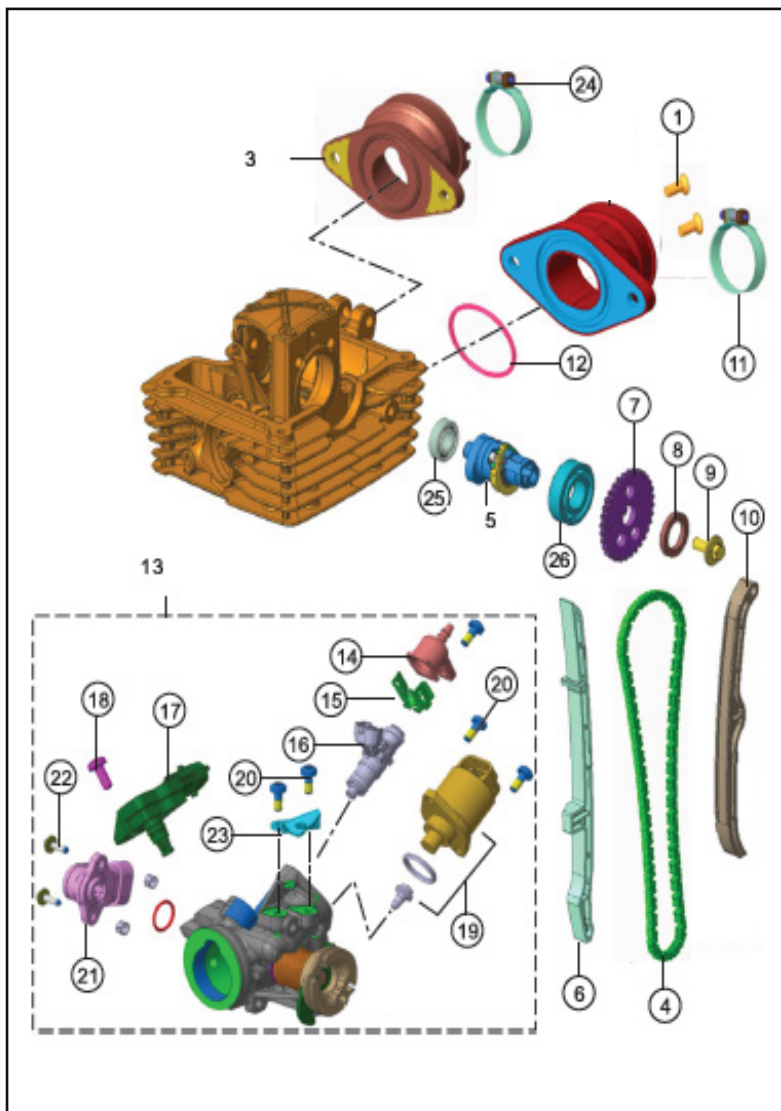


FIG. No.	PARTE No.	DESCRIPCIÓN	CANT.	OBSERVACIÓN
1	0332228	Tornillo	2	
3	NF040550	Aislador Completo	1	
4	N9011570	Cadenilla	1	
5	NF010020	Eje De Leva Completo	1	
6	N9011590	Guía Tensor Cadenilla	1	
7	N9011560	Piñón De Distribución	1	
8	N9011490	Arandela Eje De Leva	1	
9	N9200480	Tornillo	1	
10	N9011600	Guía Tensor Cadenilla	1	
13	NF040800	Sistema De Inyección	1	
14	N9042390	Tapa De Inyector	1	
15	N9042410	Soporte Inyector	1	
16	N9060750	Inyector Con O Ring	1	
17	N9060780	Sensor T Map	1	
18	M1201050	Tornillo	1	
19	N7060100	Tapón Ralentí Con O Ring	1	
20	N9325640	Tornillo Acelerador	5	
21	---	TPS	1	
22	N9325650	Tornillo M5X12	2	
23	N9325630	Soporte Acelerador	1	
24	G4041100	Abrazadera Ducto Admisión	1	
25	M1200300	Rodami. Bolas 12x28x8 C3 6001 RS	1	
26	339480	Rodami. Bolas 20x42x12 C3 6004	1	

FIGURA N° 6: CUBIERTA CLUTCH

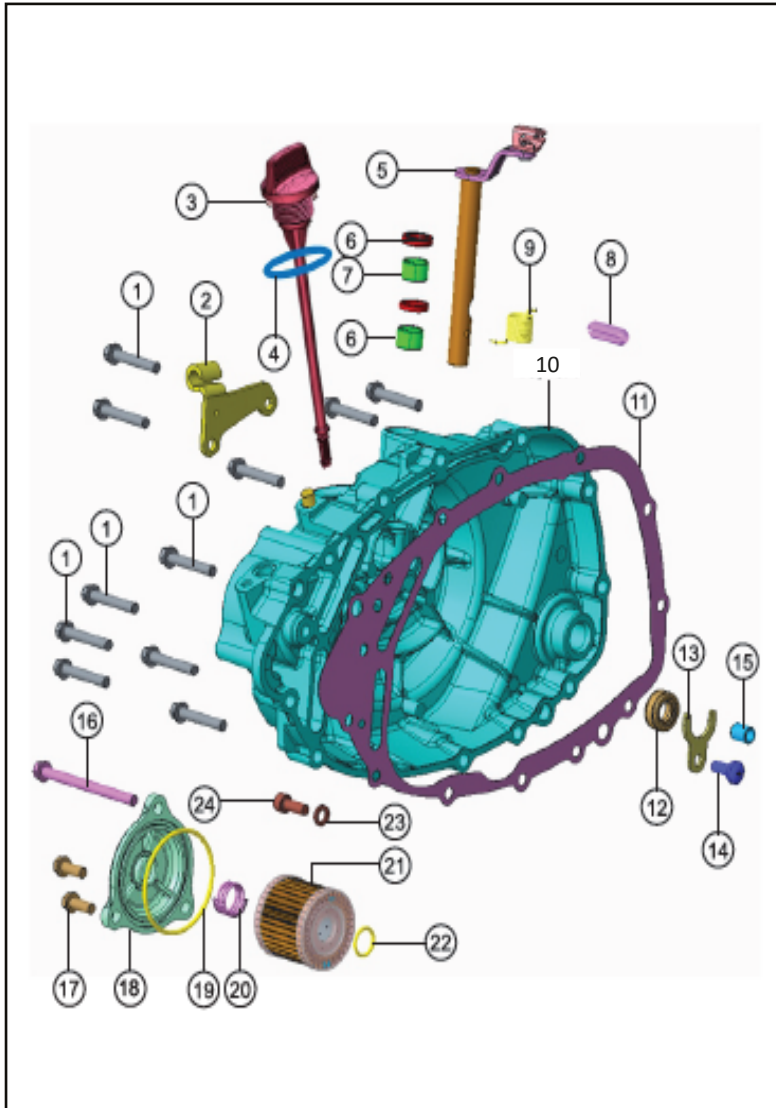


FIG. No.	PARTE No.	DESCRIPCIÓN	CANT.	OBSERVACIÓN
1	N5200170	Tornillo Motor M6X35	11	
2	M7070330	Guía Para Cable Embrague	1	
3	N9081280	Tapón Medidor Aceite	1	
4	M1080400	O Ring Varilla Medidor De Aceite 17X3	1	
5	M7070350	Leva Embrague	1	
6	M7200490	Retén Leva De Embrague 12X18X4	1	
7	M7200510	Canastilla Leva Embrague	2	
8	M7200500	Pin Piñón	1	
9	M7070380	Resorte Leva De Embrague	1	
10	N9030230	Tapa Clutch Negro	1	
11	N9030250	Empaque Tapa Clutch	1	
12	N2200550	Retenedor	1	
13	N9080670	Platina Reten Eje Crank	1	
14	0331748	Tornillo M6x16	1	
15	0074010	Pasador	2	
16	M1200440	Tornillo Motor M6X75	1	
17	M1200520	Tornillo M6X16	2	
18	M70809607D	Tapa Filtro De Aceite	1	Gris
18A	M7080960BD	Tapa Filtro De Aceite	1	Negro
19	M1080600	O Ring Tapa Filtro De Aceite	1	
20	M1080620	Resorte Filtro De Aceite	1	
21	M1080540	Filtro De Aceite	1	
22	M1080590	O Ring Filtro De Aceite 13X 2	1	
23	8200130	Arandela 6.5X11X2	1	
24	M1200790	Tornillo Hexagonal Volante	1	

FIGURA N° 8: CUBIERTA VOLANTE / VOLANTE

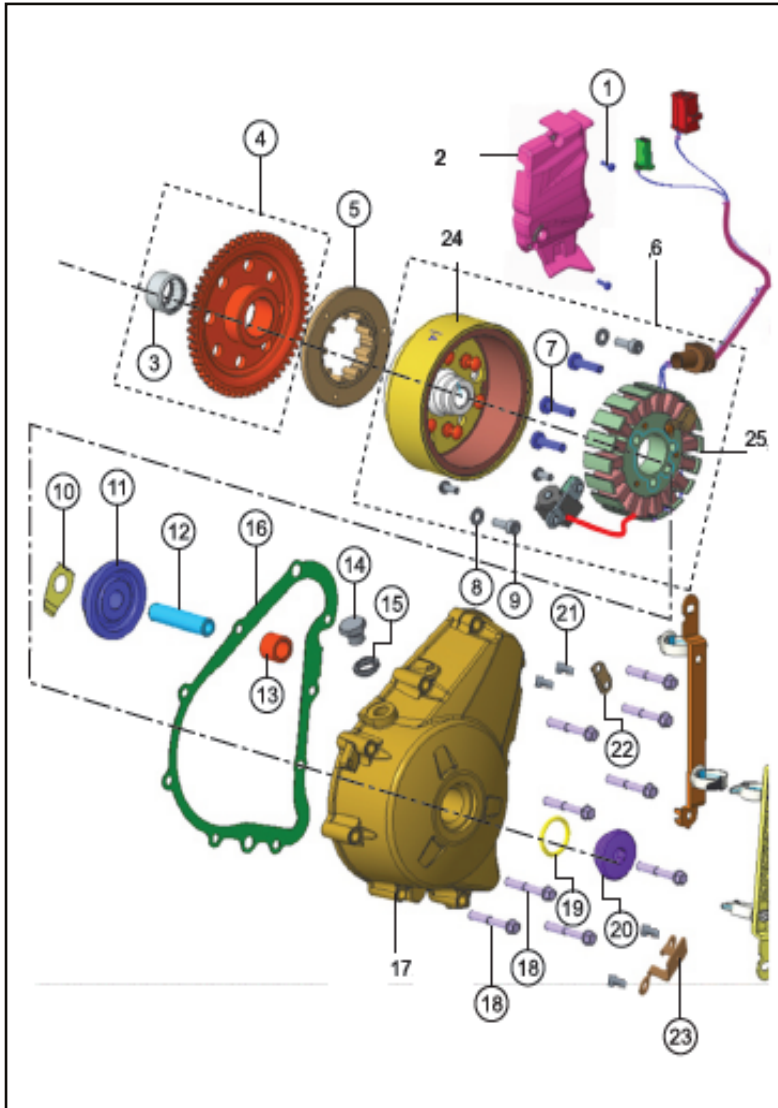


FIG. No.	PARTE No.	DESCRIPCIÓN	CANT.	OBSERVACIÓN
1	M1200670	Tornillo Cubierta Piñón De Arrastre	2	
2	N9082230	Cubierta Piñón De Arrastre	1	
3	M1200170	Canastilla Piñón De Arranque	1	
4	M1080480	Piñón Arranque Comp.	1	
5	R1060110	Bendix Arrancador	1	
6	NF060260	Volante Completo	1	
7	M1200530	Tornillo M6X20	3	
8	P1200050	Espaciador De Presión	3	
9	M1200790	Tornillo Hexagonal Volante	3	
10	N9080440	Tope Piñón De Arranque	1	
11	M1080460	Piñón Bendix De Arranque	1	
12	M1080430	Eje Motor Arranque	1	
13	M1080490	Buje Piñón Bendix	1	
14	N2081680	Tapón Visor Sincronización	1	
15	M1080420	Arandela Tapón De Aceite	1	
16	N9030320	Empaque Volante	1	
17	N9030330BD	Tapa Volante	1	
18	M7200700	Tornillo M6X40	9	
19	N2081690	O Ring Tapón Cubierta Volante	1	
20	M7080980	Tapón Cubierta Volante	1	
21	0331708	Tornillo M4X10	4	
22	M1070100	Seguro Volante	1	
23	N9081710	Seguro Volante	1	
24	N9325760	Volante	1	
25	NF320940	Plato Bobinas	1	

FIGURA N° 15: TANQUE DE GASOLINA Y COMPONENTES

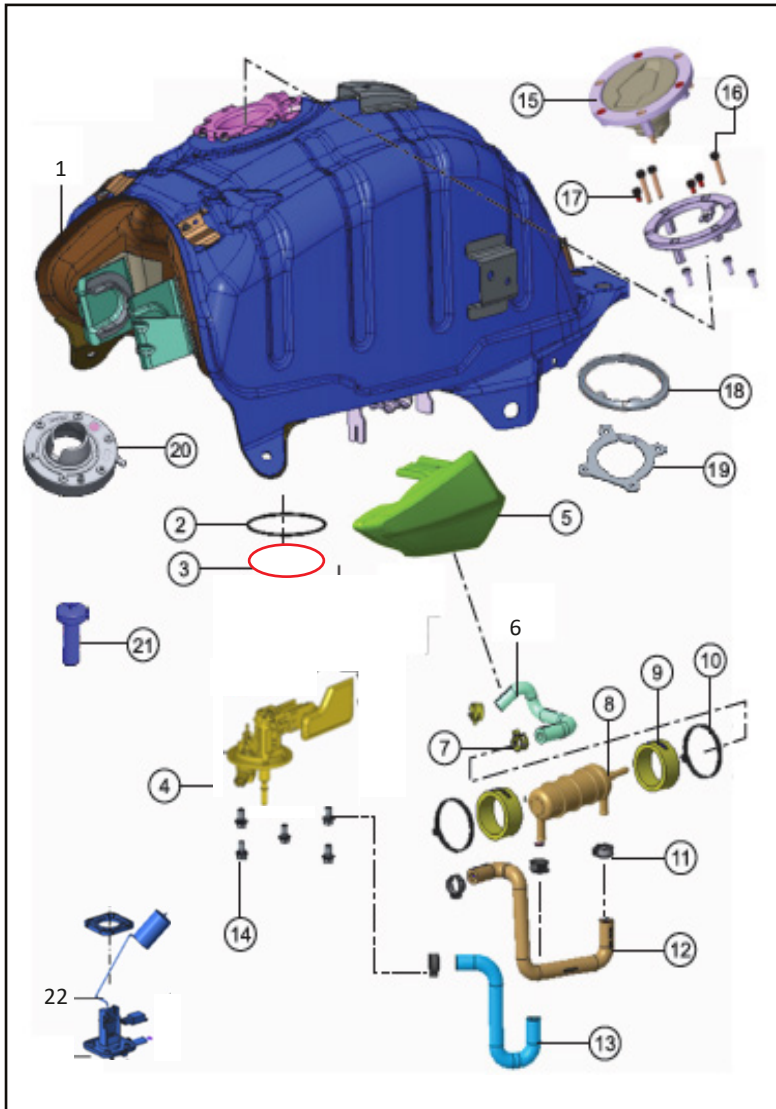


FIG. No.	PARTE No.	DESCRIPCIÓN	CANT.	OBSERVACIÓN
1	NF1401100D	Tanque Gasolina	1	
2	N7201540	O Ring 7500 260	1	
3	N7201530	O Ring 6500 260	1	
4	NF140170	Bomba Gasolina	1	
5	N9228600	Cubierta Filtro Gasolina	1	
6	NF140530	Manguera Filtro Gasolina	1	
7	R2040400	Abrazadera Manguera	2	
8	N9142140	Filtro Gasolina	1	
9	N7140240	Soporte Filtro De Gasolina	2	
10	N7201470	Correa Filtro De Gasolina	2	
11	NB140110	Abrazadera Manguera Gasolina	1	
12	N9141370	Manguera Filtro Gasolina	1	
13	N9141360	Manguera Tanque Gasolina	1	
14	N9141360	Tornillo M6x10	6	
15	N8200060	Tapa Tanque Gasolina	1	
16	N9141340	Tornillo Tanque Gasolina M5x30	3	
17	N9141340	Tornillo Hexágono M5 8	3	
18	NF140180	Empaque Bomba Gasolina	1	
19	NF140160	Empaque Inf. Bomba Gasolina	1	
20	N9141359	Complemento Tapa Tanque Gasol.	1	
21	331718	Tornillo M5x16 6.8	1	
22	NF160400	Medidor de Gasolina	1	

COMPRA SIEMPRE

REPUESTOS ORIGINALES **TVS**

CON EL RESPALDO DE AUTECO



CAMBIAMOS
PARA DARTE MÁS



FIGURA N° 24: RUEDA DELANTERA

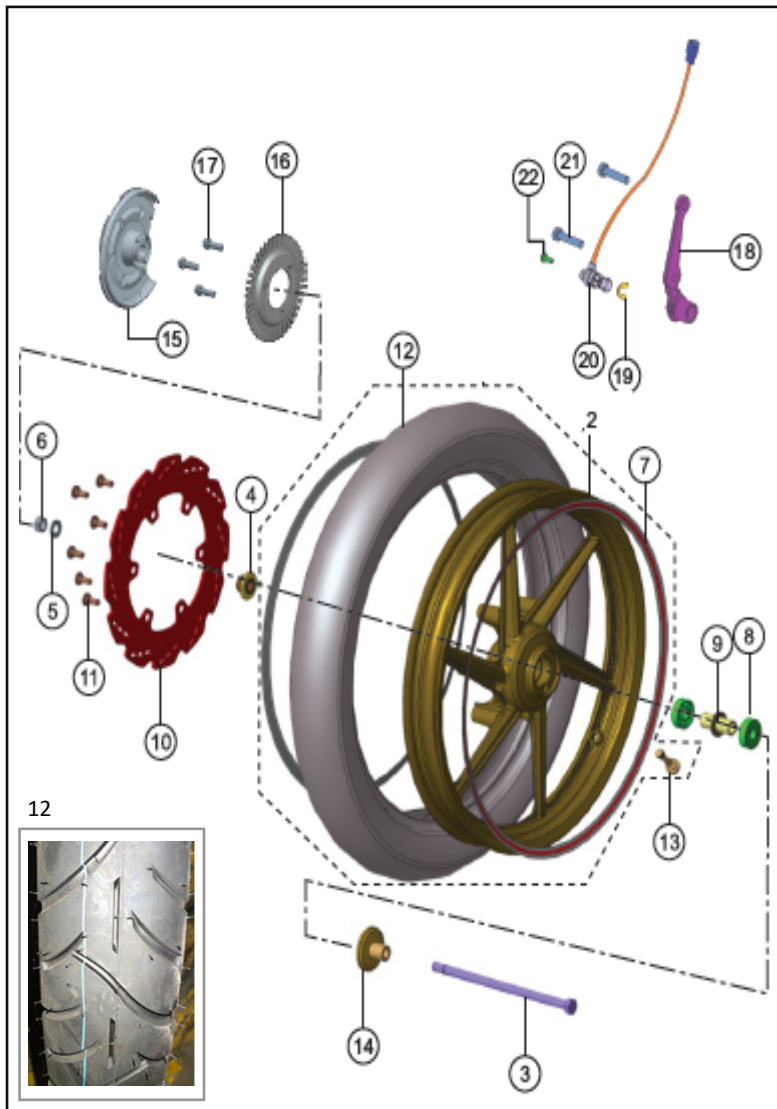


FIG. No.	PARTE No.	DESCRIPCIÓN	CANT.	OBSERVACIÓN
2	N9113640	Rin Delantero	1	
3	N3091280	Eje Delantero 12X249	1	
4	M7110100	Buje Rueda Delantera	1	
5	0335538	Arandela Eje De Trapecio	2	
6	0334158	Tuerca Eje Posterior	1	
7	N9220840	Protector Neumático Del.	2	
8	N3200010	Rodamiento Rueda Del. 12X37X12	2	
9	M7110160	Buje Interno Rueda Delantera	1	
10	N9111890	Disco Freno Delantero	1	
11	M7110090	Tornillo De Disco De Freno	6	
12	3MCY5099745F11	Llanta 90/90 R17	1	
13	N9112880	Válvula Para Llanta Sin Cámara	1	
14	N4110300	Buje Externa De Rueda	1	
15	N9113380	Protector Disco Dentado ABS	1	
16	N9113120	Disco Dentado ABS	1	
17	M1200530	Tornillo Hexágono M6X20	3	
18	N9113270	Brazo Sensor ABS Freno Del.	1	
19	N9113370	Cable Sensor de Velocidad ABS	1	
20	N9113110	Sensor De Velocidad ABS	1	
21	S1101250	Tornillo M8*35 6.8ZNB	1	
22	331708	Tornillo M5 x 12	2	

FIGURA N° 29: CUBIERTAS

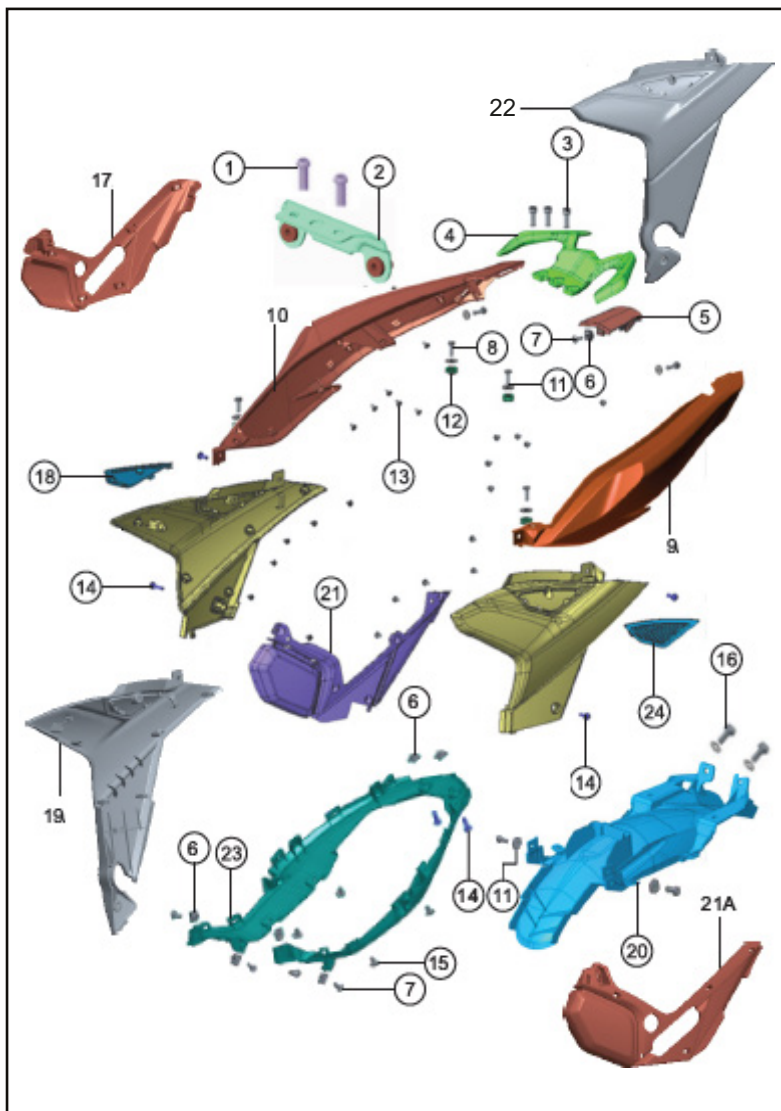


FIG. No.	PARTE No.	DESCRIPCIÓN	CANT.	OBSERVACIÓN
1	P3200010	Tornillo M6X 12	2	
2	N9229780	Soporte Guardabarro Tras.	1	
3	M1200480	Tornillo M8X25	3	
4	N92296298D	Agarradera Trasera	1	
5	N9229309	Cubierta Central Trasera	1	Parte Sin Pintar
6	S1200700	Tuerca Platina Carenaje	7	
7	0332275	Tornillo M6	5	
8	420462700	Tornillo M6X20	4	
9	N9229289	Cubierta Trasera Izquierda	1	Parte Sin Pintar
10	N9229299	Cubierta Trasera Derecha	1	Parte Sin Pintar
11	0335928	Arandela 6.5X18.0X1.6	8	
12	N3120130	Antivibrante	4	
13	N3200340	Tornillo	24	
14	N5200440	Tornillo M6 X 20	4	
15	N7201300	Remache De Plástico	4	
16	420464700	Tornillo M6X16	4	
17	NF220190	Cubierta Chasis Der.	1	
18	N9226930	Rejilla Tapa Lateral Der.	1	
19	NF220170	Tapa Lateral Der.	1	Parte Sin Pintar
20	N9229350	Guardabarro Trasero Int.	1	
21	NF220180	Cubierta Chasis Izq.	1	
22	NF220160	Tapa Lateral Izq.	1	Parte Sin Pintar
23	N9229310	Cubierta Trasera	1	
24	N9226920	Rejilla Tapa Lateral Der.	1	

FIGURA N° 30: GUARDABARRO DELANTERO

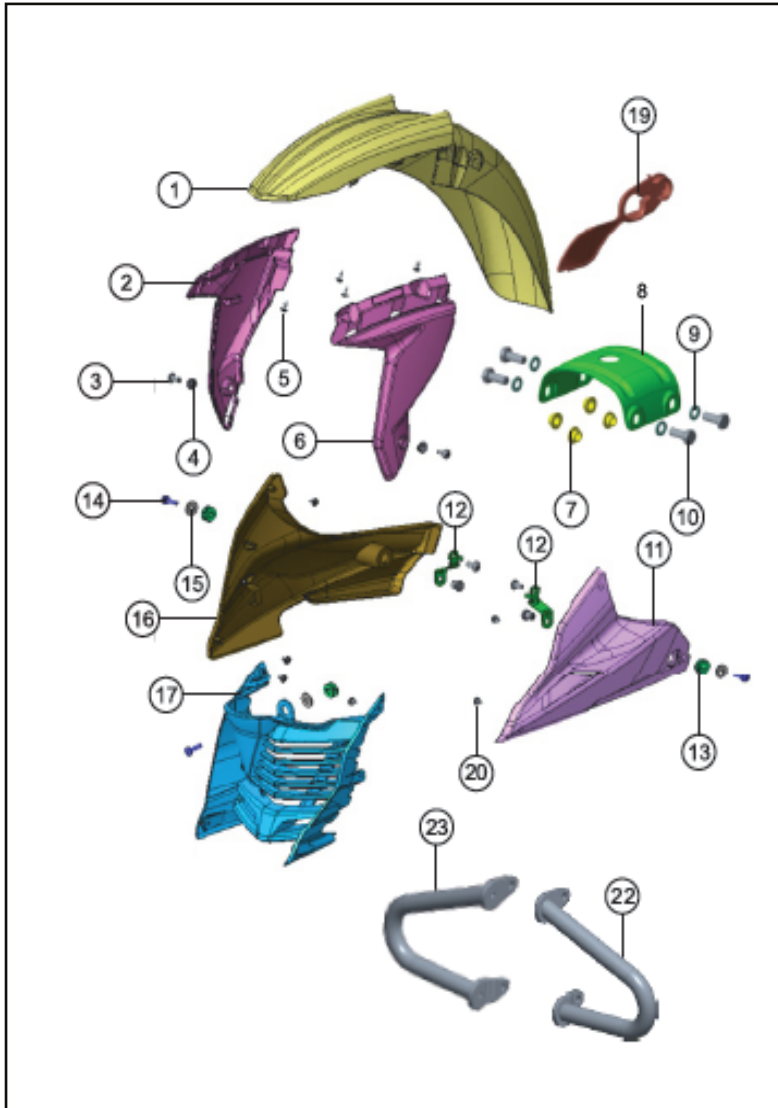


FIG. No.	PARTE No.	DESCRIPCIÓN	CANT.	OBSERVACIÓN
1	N9226069	Guardabarro Delantero	1	Parte Sin Pintar
2	N9226089	Complemento Guarda. Der.	1	Parte Sin Pintar
3	P3200010	Tornillo M6x12	2	
4	R1200260	Arandela De Copa	2	
5	K200320	Seguro	4	
6	N9226079	Complemento Guarda. Izq.	1	Parte Sin Pintar
7	M7101020	Espaciador	4	
8	M7100370	Soporte Guardabarro Del.	1	
9	330318	Arandela M8	4	
10	420454700	Tornillo M8X20 8.8	4	
11	NF225739	Cubierta Motor Izq.	1	Parte Sin Pintar
12	N9227540	Soporte Cubierta De Motor	2	
13	N3120130	Antivibrante	3	
14	332275	Tornillo M6x16 6.8	3	
15	335618	Arandela6.5x20.0x1.6	3	
16	NF225659	Cubierta Motor Der.	1	Parte Sin Pintar
17	N9225929	Cubierta Motor Central	1	
19	N9229420	Protector Central Mofle	1	
20	N3200340	Tornillo	6	
21	331058	Tornillo Con Arandela M8x16	3	
22	NF225950	Defensa Izq.	1	
23	NF227450	Defensa Der.	1	

FIGURA N° 35: INSTALACIÓN ELÉCTRICA (1/2)

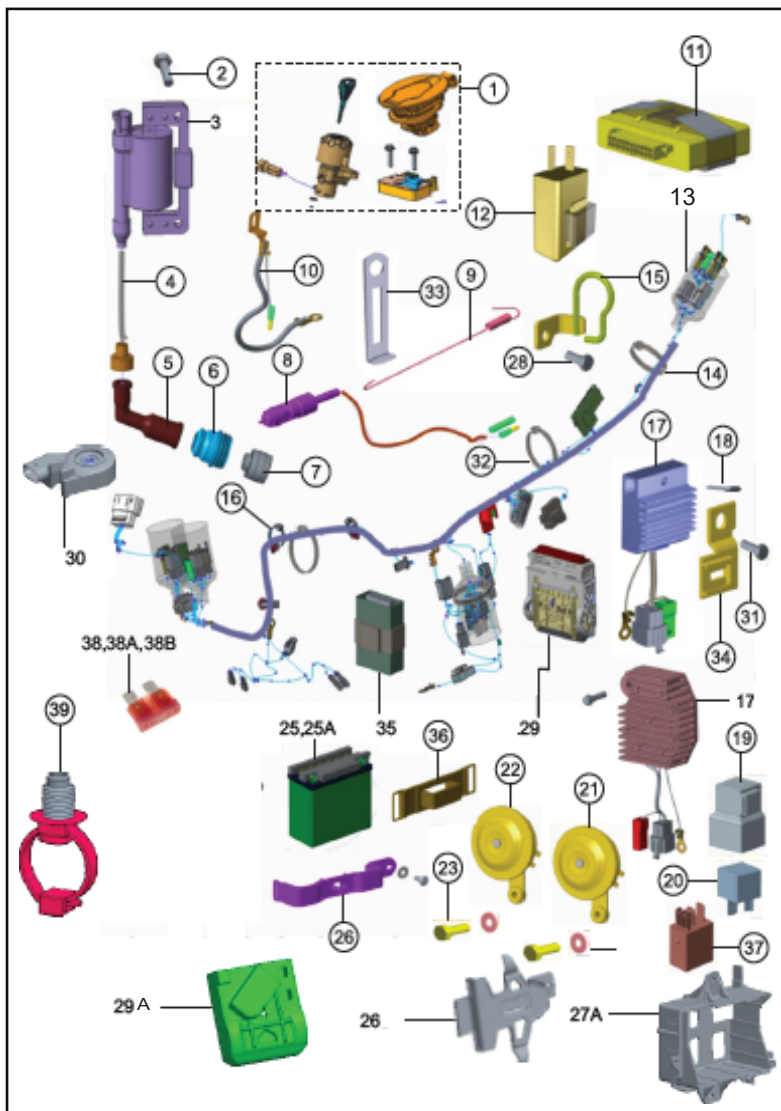


FIG. No.	PARTE No.	DESCRIPCIÓN	CANT.	OBSERVACIÓN
1	N9151910	Kit Seguro Completo	1	
2	M1200530	Tornillo M6x20	2	
3	NF060400	Bobina De Alta	1	
4	R1060200	Sello Cable Bobina De Alta	1	
5	N3060150	Capuchón Bujía	1	
6	N9060870	Aislador Térmico De Bujía	1	
7	N3060410	Sello De Bujía	1	
8	N9160900	Swiche Freno Trasero	2	
9	N8111110	Resorte De Swiche Freno	1	
10	N9162420	Conjunto De Cables	1	
11	N9060880	Unidad TCI	1	
12	N9160380	Flasher De Direccionales	1	
13	NR160120	Instalación Eléctrica	1	
14	N3160340	Amarradera Plástica	1	
15	N9142110	Guía Manguera	1	
16	N3160310	Abrazadera	1	
17	NF160520	Regulador DC EFI	1	
18	N2200500	Tornillo M6X25	1	
19	N9162500	Capuchón De Relay	1	
20	NF160730	Relay De Arranque	1	
21	N9160850	Pito Izq.	1	
22	N9160840	Pito Der.	1	
23	420454700	Tornillo Hexágono M8X20	2	
24	G5200400	Arandela	2	
25		Batería	1	

FIGURA N° 37: BOMBA FRENO DELANTERA (1/2)

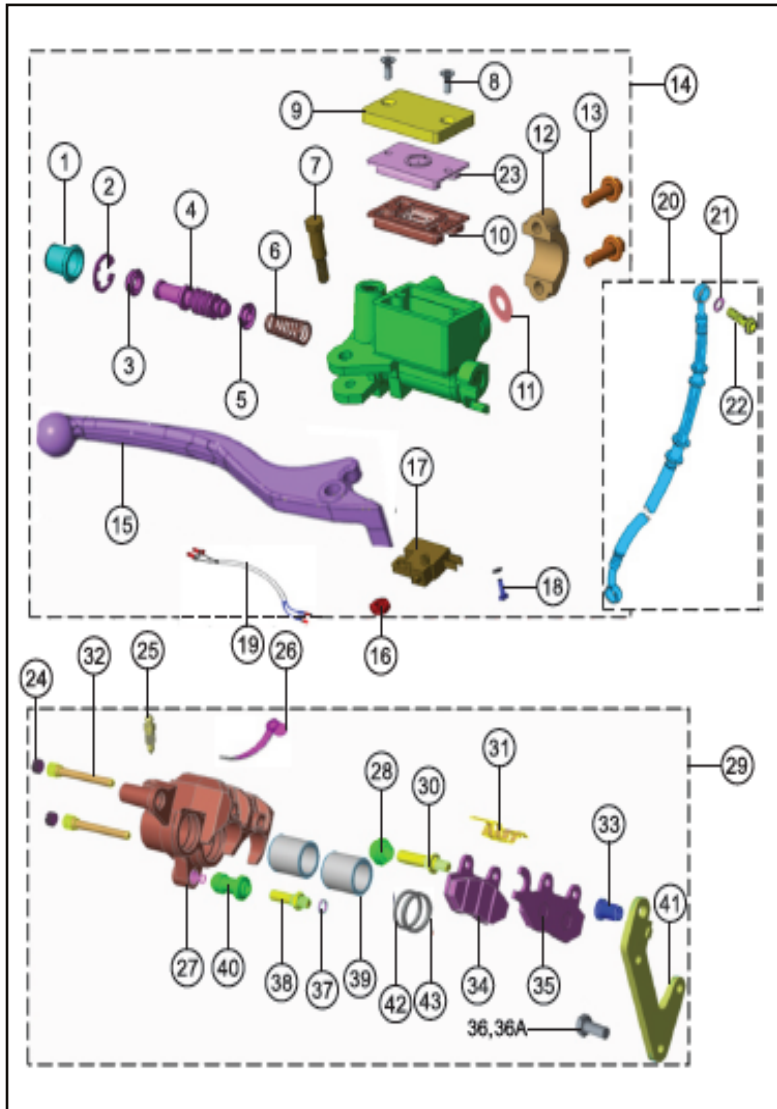


FIG. No.	PARTE No.	DESCRIPCIÓN	CANT.	OBSERVACIÓN
1	---	Buje Montaje Empaquetadura	1	Ref. en Kit N9322840
2	---	Arandela Pinadora	1	Ref. en Kit N9322840
3	---	Empaque S	1	Ref. en Kit N9322840
4	---	Pistón	1	Ref. en Kit N9322840
5	---	Empaque P	1	Ref. en Kit N9322840
6	---	Resorte	1	Ref. en Kit N9322840
7	---	Tornillo Leva	1	Ref. en Kit N9322020
8	---	Tornillo Tapa Bomba	2	Ref. en Kit N9321530
9	---	Tapa Bomba De Frena	1	Ref. en Kit N9321530
10	---	Diafragma	1	Ref. en Kit N9322840
11	---	Arandela De Sello	1	Ref. en Kit N9322840
12	---	Abrazadera Bomba De Freno	1	Ref. en Kit N9321510
13	---	Tornillo Abrazadera	2	Ref. en Kit N9321510
14	N9115100	Bomba Freno Delantero	1	
15	---	Leva Freno	1	Ref. en Kit N9322020
16	---	Tuerca	1	Ref. en Kit N9322020
17	---	Swiche Freno Del.	1	Ref. en Kit N9321520
18	---	Tornillo con Tuerca	1	Ref. en Kit N9321520
19	---	Cable Swiche Freno Del.	1	Ref. en Kit N9321520
20	---	Manguera Freno Del.	1	
21	N9111330	Arandela De Cobre Manguera Freno	4	Ref. en Kit N9321540
22	M7110330	Tornillo Especial De Freno	2	Ref. en Kit N9321540
23	---	Diafragma Depósito Líquido Freno	1	
24	---	Pin	2	

FIGURA N° 43A: CALCOMANIAS APACHE 160 FI NEGRO NEBULOSA / ROJO

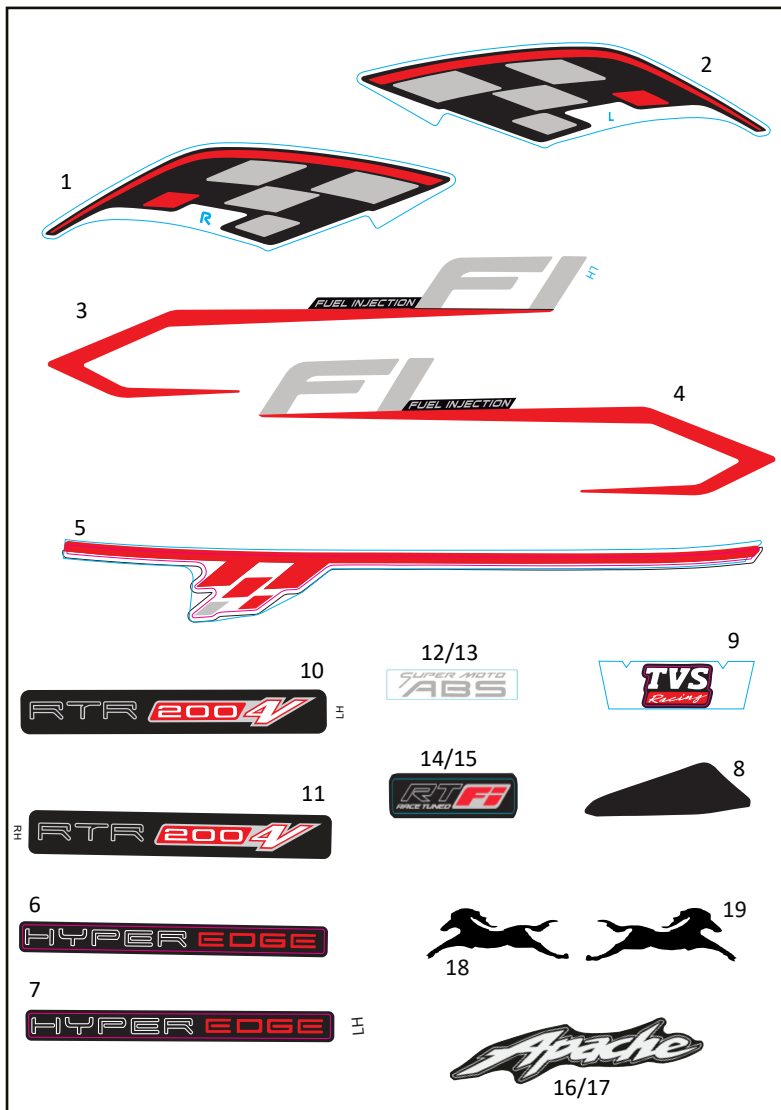


FIG. No.	PARTE No.	DESCRIPCIÓN	CANT.	OBSERVACIÓN
1	20015175	Calcomanía Cub. Tanq Der.	1	
2	20015176	Calcomanía Cub. Tanq Izq.	1	
3	20015177	Calcomanía Cub. Sill Der. Inf.	1	
4	20015178	Calcomanía Cub. Sill Izq. Inf.	1	
5	20015179	Calcomanía Cub. Tanq Cent Ng	1	
6	20015267	Calcomanía Quilla Izq. Inf-Front	1	
7	20015268	Calcomanía Quilla Der. Inf-Front	1	
8	20015269	Calcomanía Quilla Der. Inf-Izq	1	
9	20015270	Calcomanía Guard Del Cent Sup	1	
10	20015271	Calcomanía Cub. Sill Izq. Sup	1	
11	20015272	Calcomanía Cub. Sill Der. Sup	1	
12	20014787	Calc. ABS Apache 160 FI Izq.	1	
13	20014788	Calc. ABS Apache 160 FI Der.	1	
14	20014786	Calc. FI Apache Izq.	1	
15	20014806	Calc. FI Apache Der.	1	
16	20013989	Calc. Tapa Lat. SL Der.	1	
17	20013990	Calc. Tapa Lat. SL Izq.	1	
18	20014484	TVS LOGO Tanque Izq. Negro	1	
19	20014485	TVS LOGO Tanque Der. Negro	1	

LISTA DE KITS

Item	Referencia	Descripción	Contenido del Kit
1	N9325460	Kit Carcasa Centro Motor Der.	Carcasa Central Derecha Brazo Cambio De Marcha
2	M7321890	Kit Discos De Clutch	Discos De Clutch
3	N9325450	Kit Carcasa Centro Motor Izq.	Carcasa Central Izquierda Boquilla Para Desfogue Eje De Engranaje
4	N9020460	Anillos Pistón	Pistón 6200 Anillos Pistón Anillos De Aceite Pistón Pin Pistón
5	N9326200	Kit Cilindro Con Pistón	Cilindro Anillos Pistón Empaque cilindro Empaque Culata
6	M7322020	Kit Anillos STD	Anillos Pistón STD Anillos Pistón 2 STD Anillos Pistón
7	M1320340	Kit O Rings motor	O Ring Filtro Aceite 13X2 O Ring Tapa 52X2.4 O Ring Medidor 17X3 O Ring 60X2.4 Tapa O Ring Tapa Volante 23X3

LISTA DE KITS

Item	Referencia	Descripción	Contenido del Kit
8	N9325820	Kit Válvulas Motor	Válvula De Admisión Válvula De Escape Arandela De Válvula Resorte Válvula Retenedor Resorte Válvula Seguro De Válvula
9	N9325440	Kit Empaques Motor	Reten 12X22X9 Reten Cigüeñal Lado Der. Reten Salida 20X40X6 Reten Leva Clutch 12X18X4
10	NF321280	Kit Sprocket Cadena	Sprocket 45T Cadena 136L Piñón Salida 13Dx4.28 Arandela Pin Piñón Salida
11	N9325190	Kit Cunas Dirección	Cuna Dirección Chasis Inf. Pistas De Cuna Superior Balines De Dirección Guardapolvo Suspensión Pista Inferior De Dirección
12	M7321900		Separadores Discos Clutch

ÍNDICE DE REFERENCIAS

PARTE No.	FIG. No.	PAG. No.
74010	37	9
258570	12	37
330318	26	35
330318	9	40
330328	28	25
330328	39	44
330328	39	46
331058	21	40
331708	22	33
331718	21	21
331748	19	8
332275	9	36
332275	14	40
335528	17	24
335608	6	36
335608	9	37
335618	15	18
335618	15	40
335628	5	19
335928	30	42
339480	26	3
1181150	17	34
1182200	19	34
1339120	13	34
1339510	18	34
1339520	20	34
7130020	16	23
8200120	28	32
20015170	1	59
20015171	2	59
20015172	3	59
20015173	4	59

PARTE No.	FIG. No.	PAG. No.
20015174	5	59
20015175	1	60
20015176	2	60
20015177	3	60
20015178	4	60
20015179	5	60
20015180	1	61
20015181	2	61
20015182	3	61
20015183	4	61
20015184	5	61
20015267	6	59
20015267	6	60
20015267	6	61
20015268	7	59
20015268	7	60
20015268	7	61
20015269	8	59
20015269	8	60
20015269	8	61
20015270	9	59
20015270	9	60
20015270	9	61
20015271	10	59
20015271	10	60
20015271	10	61
20015272	11	59
20015272	11	60
20015272	11	61
410043700	20	43
410043700	20	45
410058700	14	45

PARTE No.	FIG. No.	PAG. No.
420302700	28	42
420454700	10	40
420955700	7	26
0064014	2	6
0074010	15	10
0330048	19	27
0330048	17	28
0330174	6	15
0330318	6	26
0330318	2	28
0330318	28	54
0330328	11	29
0330328	12	38
0330328	2	41
0331688	5	17
0331708	12	8
0331708	21	12
0331708	12	20
0331708	13	23
0331748	10	6
0331748	14	10
0332228	1	3
0332248	3	13
0332275	16	18
0332275	5	24
0332275	7	39
0332275	8	47
0332275	12	50
0332275	3	53
0334038	1	29
0334038	13	38
0334038	3	41

PARTE No.	FIG. No.	PAG. No.
0334146	16	41
0334158	6	33
0334158	19	50
0334548	22	25
0335538	5	33
0335538	18	50
0335608	7	17
0335608	6	24
0335608	10	50
0335628	6	29
0335876	1	20
0335928	9	38
0335928	11	39
0335936	14	41
0339204	13	28
3030515	16	28
3040510	16	13
3060510	1	11
410058700	14	43
414147000	3	22
415021000	14	31
420302700	11	41
420305700	22	14
420404000	8	11
420454700	23	48
420462700	26	14
420462700	8	39
420462700	1	47
420464700	16	39
420464700	19	41
420476700	3	20
420518700	21	32

PARTE No.	FIG. No.	PAG. No.
420955700	29	54
5227360	10	41
8200130	23	10
C8080260	25	16
G2200470	13	50
G4040330	7	18
G4041100	24	3
G5200280	29	14
G5200280	4	17
G5200380	12	24
G5200400	16	17
G5200400	24	48
G5200490	20	25
G7200070	7	43
G7200070	7	45
K080410	13	6
K122810	3	24
K130190	11	17
K140820	8	18
K200320	8	26
K200320	5	40
K200410	2	34
K200570	11	34
K200690	8	29
K200700	8	24
K200700	7	41
K210800	8	30
K3100800	23	44
K3100800	23	46
K3200450	26	44
K3200450	26	46
K3200770	2	8

NDICE DE REFERENCIAS

PARTE No.	FIG. No.	PAG. No.
K3200840	16	20
K3200840	15	23
K3200840	17	41
K3200840	4	50
K6160300	36	49
K6321070	6	37
M1010360	12	1
M1010440	13	4
M1070100	22	12
M1080010	16	5
M1080360	34	9
M1080370	24	2
M1080400	4	10
M1080420	9	8
M1080420	15	12
M1080430	12	12
M1080460	11	12
M1080480	4	12
M1080490	13	12
M1080510	25	2
M1080540	21	10
M1080560	11	8
M1080570	14	8
M1080590	22	10
M1080600	19	10
M1080610	13	8
M1080620	20	10
M1080630	15	4
M1080740	2	13
M1080830	5	13
M1081090	20	1
M1200060	13	1

PARTE No.	FIG. No.	PAG. No.
M1200070	23	7
M1200170	3	12
M1200250	14	4
M1200260	1	8
M1200290	7	6
M1200300	25	3
M1200380	17	11
M1200440	7	8
M1200440	16	10
M1200450	8	8
M1200470	10	24
M1200480	1	24
M1200480	3	39
M1200510	1	1
M1200510	25	7
M1200520	4	4
M1200520	4	6
M1200520	21	9
M1200520	17	10
M1200520	14	15
M1200520	9	19
M1200520	16	22
M1200520	32	44
M1200520	32	46
M1200520	28	49
M1200520	17	50
M1200530	7	12
M1200530	17	33
M1200530	2	48
M1200660	6	18
M1200660	12	36
M1200660	27	42

PARTE No.	FIG. No.	PAG. No.
M1200670	1	12
M1200670	31	49
M1200690	7	13
M1200730	3	6
M1200760	22	5
M1200760	19	6
M1200770	23	5
M1200770	11	6
M1200780	7	4
M1200790	24	10
M1200790	9	12
M1200870	21	14
M1200890	10	17
M1200890	26	25
M1200890	7	56
M1200900	8	4
M1200900	10	19
M1200900	13	36
M1200940	26	9
M1201050	18	3
M1320340	14	63
M6080090	6	13
M7011130	25	5
M7070060	11	11
M7070100	14	11
M7070110	13	11
M7070120	6	11
M7070150	9	11
M7070240	10	11
M7070290	18	11
M7070330	2	10
M7070350	5	10

PARTE No.	FIG. No.	PAG. No.
M7070380	9	10
M7080269	22	15
M7080280	8	15
M7080299	21	15
M7080320	9	15
M7080339	20	15
M7080370	23	16
M7080400	2	15
M7080470	14	13
M7080520	12	13
M7080530	9	6
M7080580	13	13
M7080590	11	13
M7080690	15	13
M7080860	7	15
M7080870	25	9
M7080890	11	15
M7080920	24	9
M70809607D	18	10
M7080960BD	18A	10
M7080980	20	12
M7081290	8	13
M7081300	10	15
M7081370	23	14
M7081400	25	14
M7081640	27	14
M7081650	31	14
M7081740	28	14
M7081810	4	13
M7081820	9	13
M7081840	18	13
M7100370	8	40

PARTE No.	FIG. No.	PAG. No.
M7100650	15	17
M7101020	7	40
M7110090	11	33
M7110090	9	34
M7110100	4	33
M7110160	9	33
M7110330	22	51
M7110330	1	53
M7110330	15	56
M7160120	23	42
M7200020	27	35
M7200250	22	9
M7200260	8	6
M7200320	1	15
M7200400	24	16
M7200410	13	15
M7200420	4	15
M7200430	26	16
M7200440	29	16
M7200450	31	16
M7200470	30	16
M7200490	6	10
M7200500	8	10
M7200510	7	10
M7200530	18	5
M7200550	24	14
M7200690	24	7
M7200690	33	14
M7200700	6	8
M7200700	18	12
M7200730	21	7
M7200730	5	8

NDICE DE REFERENCIAS

PARTE No.	FIG. No.	PAG. No.
M7200740	9	1
M7200740	15	8
M7321890	4	11
M7321890	15	63
M7321900	5	11
M7321900	16	63
M7321960	6	62
M7321970	7	62
M7322020	11	4
M7322020	5	62
N1070010	12	11
N2070200	3	11
N2081560	32	14
N2081600	22	7
N2081680	10	8
N2081680	14	12
N2081690	19	12
N2081720	19	13
N2140060	4	20
N2200470	12	26
N2200500	16	11
N2200500	1	19
N2200500	9	30
N2200500	18	48
N2200550	12	10
N3011600	6	4
N3012050	18	1
N3012100	4	1
N3060150	5	48
N3060410	7	48
N3080170	20	5
N3090240	3	34

PARTE No.	FIG. No.	PAG. No.
N3091280	3	33
N3120130	10	38
N3120130	12	39
N3120130	13	40
N3120410	11	24
N3120860	12	29
N3121540	19	25
N3121540	2	29
N3140120	5	20
N3140150	6	20
N3140160	7	20
N3140170	8	20
N3140520	5	22
N3150280	10	31
N3160220	4	56
N3160310	16	48
N3160340	14	48
N3163510	5	37
N3200010	8	33
N3200180	1	28
N3200180	15	31
N3200220	7	38
N3200340	10	20
N3200340	5	23
N3200340	11	36
N3200340	7	37
N3200340	13	39
N3200340	20	40
N3210030	1	57
N3220910	8	41
N4012000	16	1
N4110300	14	33

PARTE No.	FIG. No.	PAG. No.
N4200050	8	1
N4200130	1	22
N4221270	21	42
N5080060	12	15
N5080530	34	14
N5111210	14	50
N5120820	4	47
N5150140	12	31
N5200170	1	10
N5200180	1	17
N5200180	5	31
N5200330	14	24
N5200340	5	50
N5200350	6	56
N5200440	2	38
N5200440	14	39
N7060100	19	3
N7060140	10	22
N7060210	10A	22
N7140240	9	21
N7160620	32	49
N7201300	9	23
N7201300	15	39
N7201470	10	21
N7201530	3	21
N7201540	2	21
N7202230	22	20
N7202240	21	20
N7221090	9	41
N8011540	17	1
N8011570	15	1
N8011740	14	1

PARTE No.	FIG. No.	PAG. No.
N8040340	7	19
N8040340	17	22
N8041590	12	18
N8081090	18	8
N8111110	4	26
N8111110	9	48
N8121890	13	29
N8122610	3	47
N8130240	7	30
N8200040	23	25
N8200050	18	24
N8200050	4	29
N8200060	15	21
N8200090	27	2
N8200150	3	17
N9010320	23	2
N9010330	22	2
N9010370	10	1
N9010390	5	1
N9010720	9	4
N9010850	11	1
N9011310	5	4
N9011490	8	3
N9011550	19	1
N9011560	7	3
N9011570	4	3
N9011580	26	2
N9011590	6	3
N9011600	10	3
N9011630BD	3	4
N9011640	1	4
N9020439	20	6

PARTE No.	FIG. No.	PAG. No.
N9020460	2	62
N9020540	21	5
N9030230	10	10
N9030250	11	10
N9030320	16	12
N9030330BD	17	12
N9041940	4	18
N9042000	2	18
N9042140	9	18
N9042390	14	3
N9042410	15	3
N9042420	14	18
N9051860	3	50
N9051860	5	56
N9053170	2	17
N9053570	8	17
N9060750	16	3
N9060780	17	3
N9060820	26	7
N9060870	6	48
N9060880	11	48
N9070120	15	11
N9070280	27	32
N9070340	2	11
N9080440	10	12
N9080670	13	10
N9080760	17	13
N9081070	14	6
N9081080	17	6
N9081160	18	6
N9081280	3	10
N9081390	17	5

NDICE DE REFERENCIAS

PARTE No.	FIG. No.	PAG. No.
N9081400	1	6
N9081480	15	6
N9081490	19	5
N9081500	16	6
N9081660	27	9
N9081660	17	15
N9081670	32	9
N9081670	15	15
N9081710	23	12
N9081730	10	13
N9081810	28	16
N9081880	23	9
N9082160	5	6
N9082230	2	12
N9082240	38	9
N9092390	6	50
N9092410	21	50
N9092420	20	50
N9092430	16	50
N9092440	11	50
N9092450	4	34
N9092460	25	35
N9092470	28	35
N9092620	1	50
N9092690	8	50
N9092700	7	50
N9092710	2	50
N9092780	15	50
N9101300	27	44
N9101300	27	46
N9101470	27	25
N9101480	24	44

PARTE No.	FIG. No.	PAG. No.
N9101480	24	46
N9101520	21	43
N9101520	21	45
N9101530	22	44
N9101530	22	46
N9101540	38	44
N9101540	38	46
N9101580	28	44
N9101580	28	46
N9101600	25	44
N9101600	25	46
N9101690	35	44
N9101690	35	46
N9101740	15	43
N9101740	15	45
N9101750	17	43
N9101750	17	45
N9101760	33	44
N9101760	33	46
N9101770	34	44
N9101770	34	46
N9101790	9	43
N9101790	9	45
N9101800	19	43
N9101800	19	45
N9101810	6	43
N9101810	6	45
N9101820	4	43
N9101830	18	43
N9101840	16	43
N9101840	16	45
N9101850	40	44

PARTE No.	FIG. No.	PAG. No.
N9101850	40	46
N9101860	11	43
N9101860	11	45
N9101870	3	43
N9101870	3	45
N9101880	29	44
N9101880	29	46
N9101930	10	43
N9101940	31	44
N9101940	31	46
N9101950	30	44
N9101950	30	46
N9110700	5	34
N9111300	28	65
N9111330	21	51
N9111330	30	54
N9111330	14	56
N9111340	8	34
N9111840	27	54
N9111890	10	33
N9111930	29	52
N9112000	21	27
N9112010	20	27
N9112060	1	55
N9112070	4	53
N9112190	6	34
N9112880	13	33
N9112880	1	34
N9113110	20	33
N9113120	16	33
N9113270	18	33
N9113370	19	33

PARTE No.	FIG. No.	PAG. No.
N9113380	15	33
N9113410	4	55
N9113640	2	33
N9113990	16	34
N91140202P	14	34
N9114080	23	35
N9114140	22	35
N9114160	12	34
N9114460	2	53
N9114650	26	54
N9114740	37	44
N9114740	37	46
N9115100	2	31
N9115100	14	51
N9115210	30	9
N9121790	15	28
N9123920	18	27
N9123930	25	27
N9124000	24	27
N9124020	13	26
N9124030	27	27
N9124040	16	27
N9124050	14	26
N9124890	23	28
N9125580	5	28
N9125590	4	28
N9125670	2	56
N9125680	10	56
N9125690	3	56
N9125790	13	56
N9125990	26	27
N9127220	3	29

PARTE No.	FIG. No.	PAG. No.
N9127360	13	24
N9127640	22	42
N9127670	2	24
N9127770	2	26
N9127790	18	28
N9127800	8	28
N9127810	6	28
N9128790	9	29
N9128800	5	29
N9128840	24	25
N9128850	25	25
N9130120	5	30
N9130330	6	30
N9130350	4	30
N9141000	10	36
N9141340	15	20
N9141340	16	21
N9141340	17	21
N9141359	20	21
N9141360	13	21
N9141360	14	21
N9141370	12	21
N9141430	15	22
N9141440	2	22
N9141450	11	22
N9141650	7	22
N9142050	14	22
N9142060	8	22
N9142110	15	48
N9142140	8	21
N9142220	6	22
N91423100D	1	21

NDICE DE REFERENCIAS

PARTE No.	FIG. No.	PAG. No.
N91504403C	11	31
N9150450	25	32
N91505203C	13	31
N9151910	1	48
N9151920	23	32
N9151950	7	31
N9151960	6	31
N9151970	15	41
N9152130	10	30
N9152290	16	31
N9160380	12	48
N9160840	22	48
N9160850	21	48
N9160900	3	26
N9160900	8	48
N9161260	37	49
N9161910	12	56
N9162390	22	32
N9162420	10	48
N9162500	19	48
N9162650	4	38
N9162650	4	41
N9162750	34	49
N9162920	35	49
N9162990	24	42
N9163110	29A	49
N9170340	26	32
N9170370	11	30
N9180600	6	19
N9180610	3	19
N9180640	8	19
N9180790	18	20

PARTE No.	FIG. No.	PAG. No.
N9200230	30	14
N9200250	8	43
N9200250	8	45
N9200300	10	26
N9200310	15	26
N9200400	17	27
N9200410	18	31
N9200480	9	3
N9200530	22	50
N9200550	19	20
N9200570	9	50
N9200590	12	6
N9200590	3	8
N9220760	5	36
N9220760	8	37
N9220840	7	33
N9220840	21	34
N9221040	14	23
N9221070	17	31
N9221170	24	32
N9225730	7	47
N9225760	1	41
N9225770	6	41
N9225810	2	36
N9225860	14	28
N9225870	3	28
N9225929	17	40
N9226069	1	40
N9226069	10	58
N9226079	6	40
N9226079	12	58
N9226089	2	40

PARTE No.	FIG. No.	PAG. No.
N9226089	11	58
N9226099	8	23
N9226099	2	58
N9226109	7	23
N9226109	1	58
N9226110	1	23
N9226120	2	23
N9226240	26	42
N9226269	6	23
N9226830	8	36
N9226900	3	23
N9226910	4	23
N9226920	24	39
N9226930	18	39
N9227200	12	41
N9227540	12	40
N9227820	12	23
N9228600	5	21
N9229289	9	39
N9229289	6	58
N9229299	10	39
N9229299	7	58
N9229309	5	39
N9229309	5	58
N9229310	23	39
N9229320	5	47
N9229340	13	41
N9229350	20	39
N9229360	18	41
N9229420	19	40
N92296298D	4	39
N9229780	2	39

PARTE No.	FIG. No.	PAG. No.
N9229850	12	22
N9321510	20	64
N9321520	25	65
N9321530	19	64
N9321550	26	65
N9321600	27	65
N9321860	18	64
N9322020	1	31
N9322020	22	64
N9322190	33	66
N9322240	30	65
N9322250	31	65
N9322260	32	66
N9322270	29	65
N9322840	21	64
N9325190	11	63
N9325230	17	64
N9325270	23	64
N9325280	24	65
N9325440	9	63
N9325450	12	63
N9325460	6	6
N9325460	13	63
N9325500	21	28
N9325510	20	28
N9325610	5	38
N9325610	5	41
N9325630	23	3
N9325640	20	3
N9325650	22	3
N9325680	13	43
N9325680	13	45

PARTE No.	FIG. No.	PAG. No.
N9325690	2	43
N9325690	2	45
N9325700	5	43
N9325700	5	45
N9325720	12	43
N9325720	12	45
N9325760	24	12
N9325780	28	9
N9325790	33	9
N9325820	8	63
N9325830	38	49
N9325840	38A	49
N9325850	38B	49
N9326200	1	62
N9326230	3	62
N9326240	4	62
N9326260	10	63
NB140110	11	21
ND040210	19	18
ND120450	10	29
NF010020	5	3
NF010030	28	2
NF010080	21	2
NF010090	3	1
NF010101	2	1
NF020040	12	4
NF020130	10	4
NF030290	4	8
NF040190	10	18
NF040370	3	18
NF040490	13	18
NF040550	3	3

FICHA TÉCNICA APACHE RTR 160 FI

CARACTERÍSTICA	UNIDAD
Motor	4 Tiempos, Monocilíndrico
Cilindrada	159,7 cc
Relación de Compresión	10.15:1
Potencia Máxima	17.3HP@9250 rpm(modosport) / 15.4HP@8600 rpm(modosurban-lluvia)
Torque Máximo	14.7NM@7250 rpm(modosport) / 14.1NM@7250 rpm(modosurban-lluvia)
Transmisión	Mecánica 5 Velocidades
Sistema de Alimentación	Inyección Electrónica
Refrigeración	Aire y Aceite
Diámetro x Carrera	62x52.9 mm
FRENOS	
Freno Delantero	Disco (270mm), Pinza Flotante 2 Émbolos
Freno Trasero	Disco (200mm), Pinza Flotante 1 Émbolo
SUSPENSIÓN	
Suspensión Delantera	Horquilla Telescópica
Suspensión Trasera	Monoamortiguador, Ajustable en Precarga
CAPACIDAD DEL TANQUE	
Lleno	12 L (3,17 gal), 2.28 L Reserva
Combustible	Extra
LLANTAS	
Llanta Delantera	90/90 R17
Llanta Trasera	130/70 R17
Rines	Aspas
SISTEMA ELÉCTRICO	
Sistema de Ignición	ECU
DRL / AHO	Si / No
Slipper Clutch	No
ABS	Si
DIMENSIONES	
Largo Total	2035 mm
Altura Total	1050 mm
Ancho Total	790 mm
Distancia Entre Ejes	1357 mm
Altura al Piso	200 mm
Peso Neto	145 kg

